



RT 1270E (12V7Ah)

RT1270E is a general purpose battery with 5 years floating design life, meet with IEC, JIS standard. With heavy duty grid, thickness plates, special additives, RT series battery have long and reliable standby service life.



Specification

Cells Per Unit	6
Voltage Per Unit	12
Capacity	7Ah@20hr-rate to 1.75V per cell @25°C
Weight	Approx. 2.0 Kg
Max. Discharge Current	70A (5 sec)
Internal Resistance	Approx. 30 mΩ
Operating Temperature Range	Discharge: -20°C~60°C Charge: 0°C~50°C Storage: -20°C~60°C
Normal Operating Temperature Range	25°C±5°C
Float charging Voltage	13.7 to 13.9 VDC/unit Average at 25°C
Recommended Maximum Charging Current Limit	2.1 A
Equalization and Cycle Service	14.6 to 14.8 VDC/unit Average at 25°C
Self Discharge	RITAR batteries can be stored for more than 6 months at 25°C. Self-discharge ratio less than 3% per month at 25°C. Please charge batteries before using.
Terminal	Faston Tab 187(F1)/Faston tab 250(F2)
Container Material	A.B.S. (UL94-HB), Flammability resistance of UL94-V2 can be available upon request.

MH28539
G4M20206-0910-E-16
ISO9001:2000 Certificate

Dimensions

Unit: mm Dimension: 151(L)×65(W)×100(H)

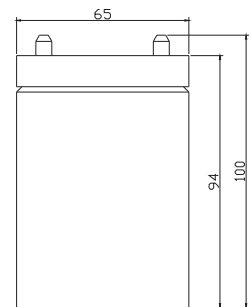
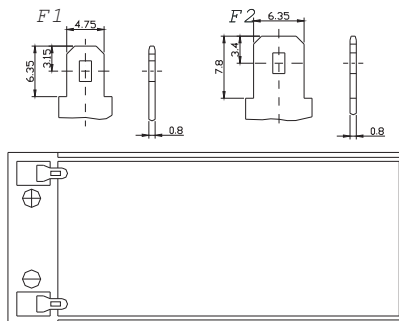
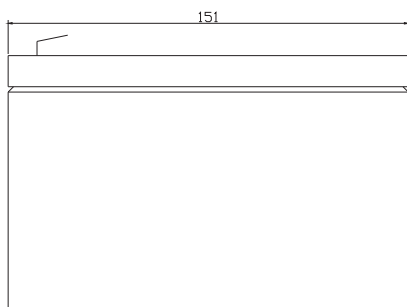

Constant Current Discharge Characteristics : A(25°C)

F.V/Time	5MIN	10MIN	15MIN	30MIN	1HR	2HR	3HR	4HR	5HR	8HR	10HR	20HR
9.60V	27.04	17.73	13.90	7.800	4.635	2.669	1.814	1.452	1.206	0.768	0.665	0.373
10.0V	26.06	17.29	13.45	7.701	4.509	2.616	1.781	1.432	1.185	0.765	0.658	0.359
10.2V	24.53	16.43	13.08	7.583	4.466	2.588	1.765	1.418	1.172	0.758	0.648	0.353
10.5V	22.05	15.36	12.33	7.374	4.378	2.554	1.749	1.404	1.158	0.751	0.645	0.342
10.8V	19.76	14.33	11.64	7.130	4.299	2.533	1.729	1.397	1.146	0.748	0.634	0.322
11.1V	17.29	13.14	10.74	6.859	4.184	2.431	1.695	1.385	1.134	0.742	0.624	0.317

Constant Power Discharge Characteristics : W(25°C)

F.V/Time	5MIN	10MIN	15MIN	30MIN	1HR	2HR	3HR	4HR	5HR	8HR	10HR	20HR
9.60V	284.5	188.6	148.8	89.29	53.82	31.14	21.20	17.18	14.27	9.195	7.964	4.471
10.0V	277.1	184.6	146.6	88.37	53.03	30.88	21.16	17.14	14.20	9.159	7.889	4.312
10.2V	263.5	177.3	144.7	87.60	52.64	30.68	21.08	17.00	14.06	9.090	7.814	4.233
10.5V	240.5	170.0	137.2	85.81	51.93	30.44	21.00	16.84	13.89	9.013	7.733	4.113
10.8V	217.0	159.1	129.6	83.78	51.08	30.18	20.75	16.78	13.75	8.974	7.615	3.874
11.1V	191.4	148.1	122.1	81.48	50.13	29.14	20.35	16.61	13.62	8.910	7.502	3.812

All mentioned values are average values.

RT 1270E

12V7Ah



Effect of temperature on long term float life

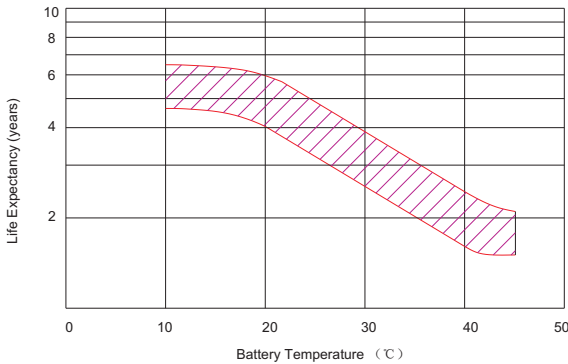

Storage characteristic

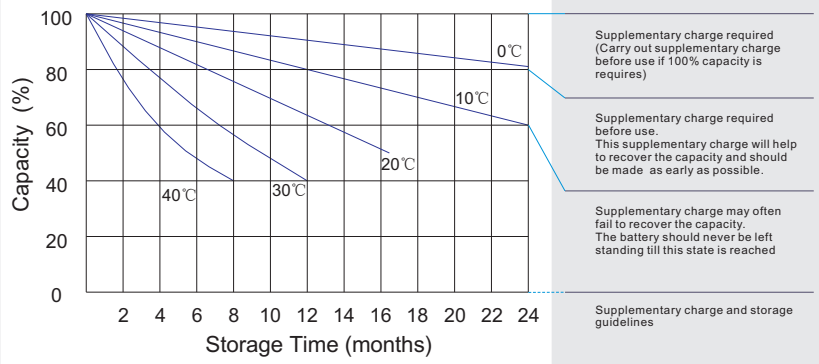

Charge characteristic Curve for standby use

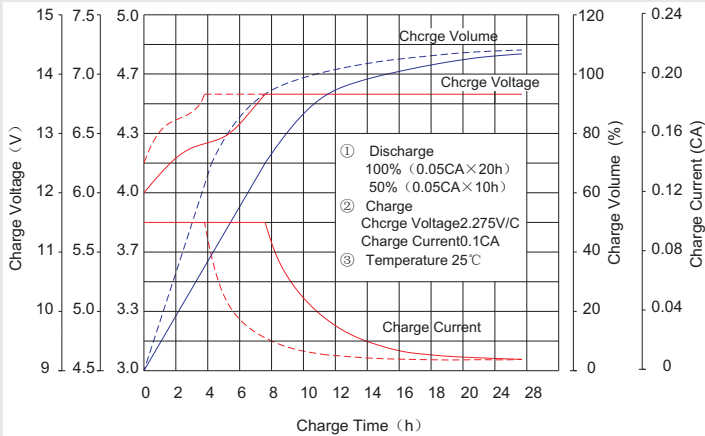

Discharge characteristic Curve

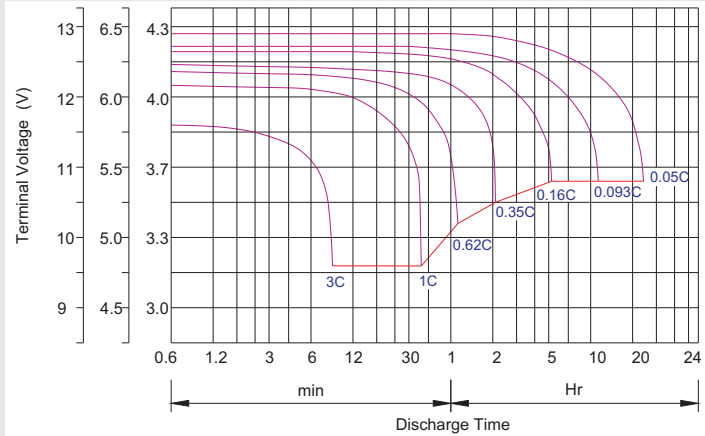

Capacity Factors With Different Temperature

Battery Type		-20°C	-10°C	0°C	5°C	10°C	20°C	25°C	30°C	40°C	45°C
GEL Battery	6V&12V	50%	70%	83%	85%	90%	98%	100%	102%	104%	105%
	2V	60%	75%	85%	88%	92%	99%	100%	103%	105%	106%
AGM Battery	6V&12V	46%	66%	76%	83%	90%	98%	100%	103%	107%	109%
	2V	55%	70%	80%	85%	92%	99%	100%	104%	108%	110%

Discharge Current VS. Discharge Voltage

Final Discharge Voltage V/cell	1.75V	1.70V	1.60V
Discharge Current (A)	(A) ≤ 0.2C	0.2C < (A) < 1.0C	(A) ≥ 1.0C

Charge the batteries at least once every six months, if they are stored at 25°C.

Charging Method:

Constant Voltage	-0.2Cx2h+2.4~2.45V/Cellx24h, Max. Current 0.3CA
Constant Current	-0.2Cx2h+0.1CAx12h
Fast	-0.2Cx2h+0.3CAx4.0h

Maintenance & Cautions

Float Service:
※ Every month, recommend inspection every battery voltage.
※ Every three months, recommend equalization charge for one time.
Equalization charge method:
Discharge: 100% rate capacity discharge.
Charge: Max. current 0.3CA, constant voltage 2.4-2.45V/Cell charge 24h.
※ Effect of temperature on float charge voltage: -3mV/°C/Cell.
※ Length of service life will be directly affected by the number of discharge cycles, depth of discharge, ambient temperature and charging voltage.